

ANALYSIS OF GATE 2017*

Electrical Engineering

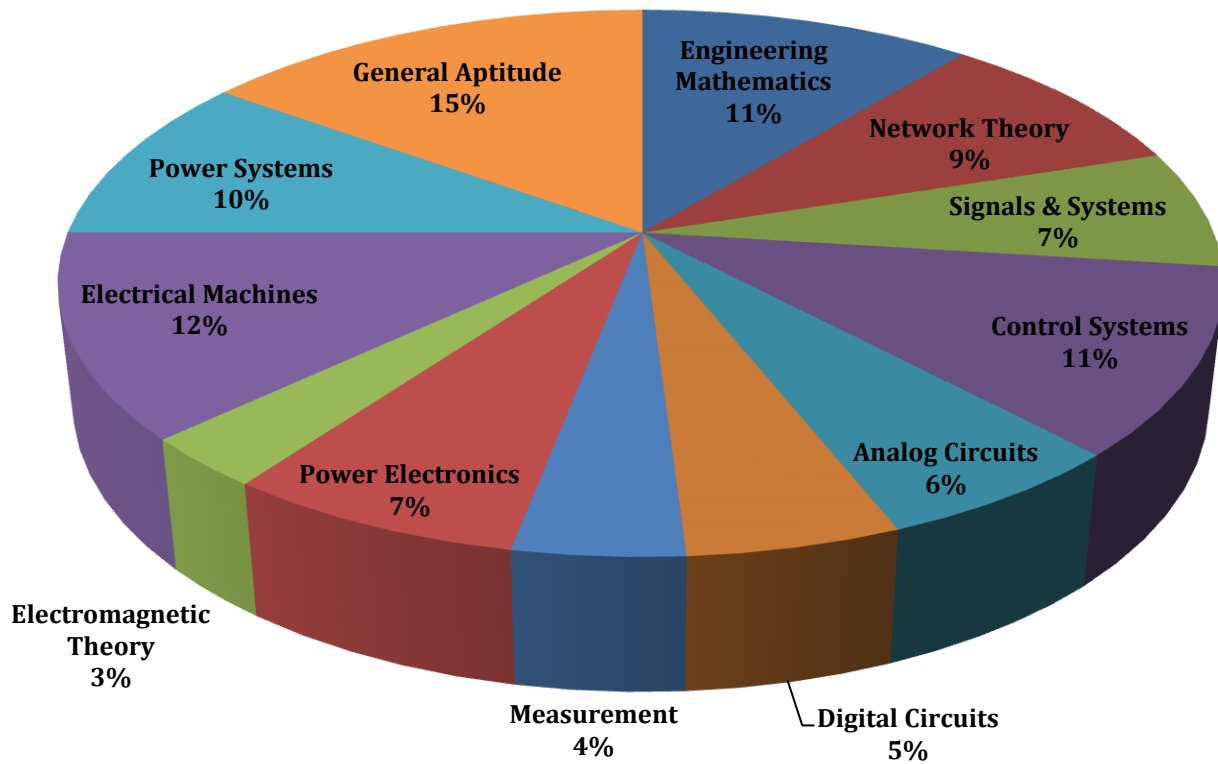

EE ANALYSIS-2017_11-Feb_Morning

SUBJECT	No. of Ques.	Topics Asked in Paper(Memory Based)	Level of Ques.	Total Marks
Engineering Mathematics	1 Marks: 3 2 Marks: 4	Linear Algebra; Calculus; Complex Variables Differential Equations; Numerical Methods	Tough	11
Network Theory	1 Marks: 3 2 Marks: 3	Network Solution Methodology; Two Port Networks; Transient/Steady State Analysis of RLC Circuits to DC Input; Miscellaneous	Medium	9
Signals & Systems	1 Marks: 3 2 Marks: 2	Fourier Representation of Signals; Linear Time Invariant (LTI) Systems;Z-Transform	Tough	7
Control Systems	1 Marks: 3 2 Marks: 4	Stability & Routh Hurwitz Criterion; Frequency Response Analysis; State Variable Analysis; Time Domain Analysis; Basics of Control System; Time Domain Analysis	Tough	11
Analog Circuits	1 Marks: 2 2 Marks: 2	Diode Circuits-Analysis and Application; Operational Amplifiers & Its Applications; AC & DC Biasing-BJT and FET; Miscellaneous	Easy	6
Digital Circuits	1 Marks: 1 2 Marks: 2	Boolean Algebra and Karnaugh Maps Logic Gates	Easy	5
Measurement	1 Marks: 2 2 Marks: 1	Measurements of Basic Electrical Quantities 1 Basic Electrical Quantities 2	Medium	4
Power Electronics	1 Marks: 3 2 Marks: 2	Inverters; Basics of Power Semiconductor Devices; Rectifiers; Choppers	Tough	7
Electromagnetic Theory	1 Marks: 1 2 Marks: 1	Electromagnetic Field	Medium	3
Electrical Machines	1 Marks: 2 2 Marks: 5	Synchronous Machine; Induction Motor; DC Machines; Transformer	Easy	12
Power Systems	1 Marks: 2 2 Marks: 4	Symmetrical Components and Faults Calculations; Transmission and Distribution; Power System Stability	Tough	10
General Aptitude	1 Marks:5 2 Marks:5		Medium	15
Total	65			100
Faculty Feedback	Majority of the question were concept based. Control, PS, Network EM, Maths weightage was comparatively high. GA was medium as compared to the last year.			

GATE 2017 Examination*
Electrical Engineering

Test Date: 11/02/2017
Test Time: 9:00 AM 12:00 PM
Subject Name: Electrical Engineering

Section: General Aptitude

1. Find the smallest number y such that $y \times 162$ is a perfect cube.
(A) 24
(B) 27
(C) 32
(D) 36

[Ans. D]

Factorization of 162 is $2 \times 3 \times 3 \times 3 \times 3$

$y \times 162$ is a perfect cube

$y \times 2 \times 3 \times 3 \times 3 \times 3 = \text{Perfect cube}$

2	162
3	81
3	27
3	9
	3

For perfect cube 2's and 3's are two more required each

i.e., $2 \times 2 \times 2 \times 3 \times 3 \times 3 \times 3 \times 3$

$y = 2 \times 2 \times 3 \times 3 = 4 \times 9 = 36$

\therefore The smallest number of $y = 36$

2. The probability that a k -digit number does NOT contain the digits 0, 5, or 9 is
(A) 0.3^k
(B) 0.6^k
(C) 0.7^k
(D) 0.9^k

[Ans. C]

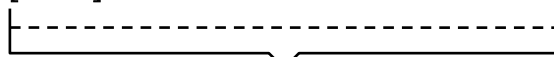

K digits

Each digit can be filled in 7 ways as 0, 5 and 9 is not allowed so, each of these places can be filled by 1, 2, 3, 4, 5, 6, 8.

So, required probability = $\left(\frac{7}{10}\right)^k = (0.7)^k$

3. After Rajendra Chola returned from his voyage to Indonesia, he _____ to visit the temple in Thanjavur.

- (A) was wishing
- (B) is wishing
- (C) wished
- (D) had wished

[Ans. C]

If the main clause is in the past the past tense, the subordinate clause also should be in the past tense.

4. Rahul, Murali, Srinivas and Arul are seated around a square table. Rahul is sitting to the left of Murali. Srinivas is sitting to the right of Arul. Which of the following pairs are seated opposite each other?
- (A) Rahul and Murali
 - (B) Srinivas and Arul
 - (C) Srinivas and Murali
 - (D) Srinivas and Rahul

[Ans. C]

From the given data, the following seated arrangement is possible around a square table.

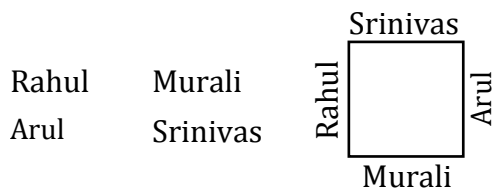

∴ Srinivas and Murali are opposite to each other

5. Research in the workplace reveals that people work for many reasons _____.
- (A) money beside
 - (B) beside money
 - (C) money besides
 - (D) besides money

[Ans. D]

'Besides' means in addition to.

6. Six people are seated around a circular table. There are at least two men and two women. There are at least three right-handed persons. Every woman has a left-handed person to her immediate right. None of the women are right-handed. The number of women at the table is
- (A) 2
 - (B) 3
 - (C) 4
 - (D) Cannot be determined

[Ans. A]

The total Number of peoples are sitting around a circular table is 6, in which atleast 2 men, atleast 2 women and atleast three right handed persons are compulsory. From this data, the following circular form is possible.

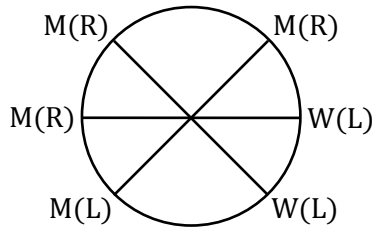

M = Male
W = Women
L = Left hand
R = Right hand

∴ The number of women on the table is 2.

7. Arun, Gulab, Neel and Shweta must choose one shirt each from a pile of four shirts coloured red, pink, blue and white respectively. Arun dislikes the colour red and Shweta dislike the colour white. Gulab and Neel like all the colours. In how many different ways can they choose the shirts so that no one has a shirt with a colour he or she dislikes?
- (A) 21
(B) 18
(C) 16
(D) 14

[Ans. D]

Persons are Arun, Gulab, Neel and Shweta shirt colours are red, pink, blue and white
 → Arun dislike red colour means he like remaining three other colours
 → Shweta dislike white colour means he like remaining three other colours
 → Gulab and Neel are likes all the four colours
 → The total Number of ways to choose shifts = 3 + 3 + 4 + 4 = 14

8. The expression $\frac{(x+y)-|x-y|}{2}$ is equal to
- (A) The maximum of x and y
(B) The minimum of x and y
(C) 1
(D) None of the above

[Ans. B]

$$\frac{(x+y) + |x-y|}{2} \dots \dots \dots \textcircled{1}$$

$|x-y| = \pm(x-y)$, if $(x-y)$ when $x > y$

if $-(x-y) = (y-x)$ when $y > x$

$$\frac{(x+y) + (x-y)}{2} = \frac{x+y-x+y}{2}$$

$$= \frac{2y}{2} = y$$

= Minimum of (x, y)

as $(x > y)$

$$\frac{(x+y) + (y-x)}{2} = \frac{x+y-y-x}{2}$$

$$= \frac{2x}{2} = x$$

$$= \text{Minimum of } (x, y)$$

as $x < y$

9. "The hold of the nationalist imagination on our colonial past is such that anything inadequately or improperly nationalist is just not history."
Which of the following statements best reflects the author's opinion?
- (A) Nationalists are highly imaginative
(B) History is viewed through the filter of nationalism
(C) Our colonial past never happened
(D) Nationalism has to be both adequately and properly imagined

[Ans. B]

To refer is to reach an opinion. The right opinion of the author is 'History is viewed through the filter of nationalism' so, option B is the right opinion of the author. The key words in the statement are 'history and nationalist imagination'.

10. A contour line joins locations having the same height above the mean sea level. The following is a contour plot of a geographical region. Contour lines are shown at 25 m intervals in this plot. If in a flood the water level rises to 525 m, which of the villages P, Q, R, S, T get submerged?

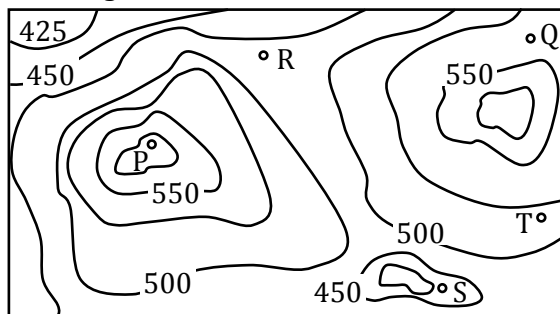

- (A) P, Q
(B) P, Q, T
(C) R, S, T
(D) Q, R, S

[Ans. C]

The given contour is a hill station, the peak point of this hill station is P, it is under a contour of 550. At floods, the water level is 525 m. So, the village of R, S and T are under a contour of 500. Therefore these villages are submerged.

Section: Technical

1. The equivalent resistance between the terminals A and B is _____ Ω .

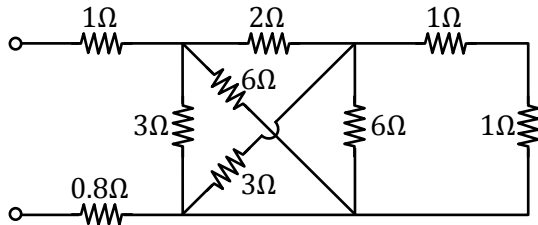

[Ans. *] Range: 2.9 to 3.1

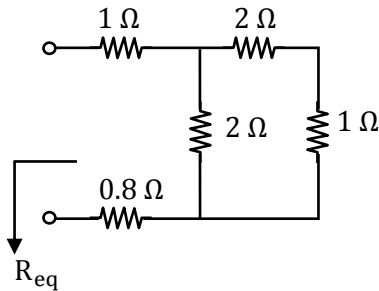

$$R_{eq} = 1.8 + [2 \parallel 3]1.8 + \frac{6}{5} = 3 \Omega$$

2. The matrix $A = \begin{bmatrix} \frac{3}{2} & 0 & \frac{1}{2} \\ 0 & -1 & 0 \\ \frac{1}{2} & 0 & \frac{3}{2} \end{bmatrix}$ has three distinct eigen values and one of its eigen vectors is $\begin{bmatrix} 1 \\ 0 \\ 1 \end{bmatrix}$

Which one of the following can be another eigen vector of A?

- (A) $\begin{bmatrix} 0 \\ 0 \\ -1 \end{bmatrix}$
 (B) $\begin{bmatrix} -1 \\ 0 \\ 0 \end{bmatrix}$
 (C) $\begin{bmatrix} 1 \\ 0 \\ -1 \end{bmatrix}$
 (D) $\begin{bmatrix} 1 \\ -1 \\ 1 \end{bmatrix}$

[Ans. C]

Since eigen values are distinct and the matrix is symmetric then the corresponding eigen vectors are orthogonal

$$\text{Then } X_1^T X_2 = 0$$

By verification from options,

$$\text{Given } X_1 = \begin{bmatrix} 1 \\ 0 \\ 1 \end{bmatrix}, \text{ Let } X_2 = \begin{bmatrix} 1 \\ 0 \\ -1 \end{bmatrix}$$

$$\therefore X_1^T X_2 = 0$$

3. A 3-bus power system is shown in the figure below, where the diagonal elements of Y-bus matrix are: $Y_{11} = j12$ pu, $Y_{22} = j15$ pu and $Y_{33} = j7$ pu.

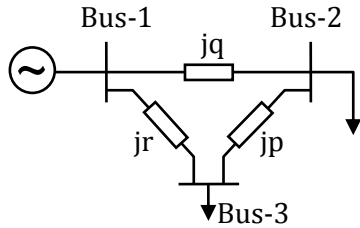

The per unit values of the line reactances p, q and r shown in the figure are

- (A) $p = -0.2, q = -0.1, r = -0.5$
 (B) $p = 0.2, q = 0.1, r = 0.5$
 (C) $p = -5, q = -10, r = -2$
 (D) $p = 5, q = 10, r = 2$

[Ans. B]

$$\frac{1}{jR} + \frac{1}{jQ} = -j12 \dots \dots \dots \textcircled{1}$$

$$\frac{1}{jQ} + \frac{1}{jP} = -j15 \dots \dots \dots \textcircled{2}$$

$$\frac{1}{jP} + \frac{1}{jR} = -j7 \dots \dots \dots \textcircled{3}$$

$$\textcircled{1} \Rightarrow \frac{1}{R} + \frac{1}{Q} = 12 \dots \dots \dots \textcircled{4}$$

$$\frac{1}{Q} + \frac{1}{P} = 15 \dots \dots \dots \textcircled{5}$$

$$\frac{1}{P} + \frac{1}{R} = 7 \dots \dots \dots \textcircled{6}$$

$$\textcircled{4} + \textcircled{5} + \textcircled{6} \Rightarrow 2 \left(\frac{1}{P} + \frac{1}{Q} + \frac{1}{R} \right) = 34$$

$$\Rightarrow \left(\frac{1}{P} + \frac{1}{Q} + \frac{1}{R} \right) = 17$$

$$(7) - (4) \Rightarrow \frac{1}{P} = 5 \Rightarrow 1P = 0.2$$

$$(7) - (5) \Rightarrow \frac{1}{R} = 2 \Rightarrow R = 0.5 \text{ pu}$$

$$(7) - (6) \Rightarrow \frac{1}{Q} = 10 \Rightarrow Q = 0.1 \text{ pu}$$

4. The following measurements are obtained on a single phase load: $V = 220 \text{ V} \pm 1\%$, $I = 5.0 \text{ A} \pm 1\%$ and $W = 555 \text{ W} \pm 2\%$. If the power factor is calculated using these measurements, the worst case error in the calculated power factor in percent is _____. (Give answer up to one decimal place.)

[Ans. *] Range: 4 to 4

$$\text{Power factor } \cos\phi = \frac{P}{VI} = \frac{2\%}{1\% \times 1\%} \Rightarrow \frac{2\%}{2\%} = 1\%$$

In multiplication and division percentage values will be added up.

5. Consider an electron, a neutron and a proton initially at rest and placed along a straight line such that the neutron is exactly at the center of the line joining the electron and proton. At $t = 0$, the particles are released but are constrained to move along the same straight line. Which of these will collide first?
 (A) The particles will never collide
 (B) All will collide together
 (C) Proton and neutron
 (D) Electron and neutron

[Ans. D]

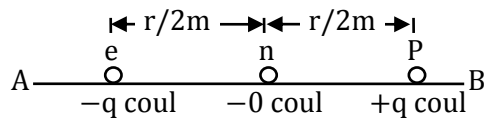

$t < 0$: The particles are at rest. No ext. field is mentioned in the problem. So the only force is that acting on e & p. This has a magnitude $\frac{q^2}{4\pi\epsilon_0 r^2}$ (attractive). No force on n. (Gravitational force neglected).

6. In the converter circuit shown below, the switches are controlled such that the load voltage $v_o(t)$ is a 400 Hz square wave.

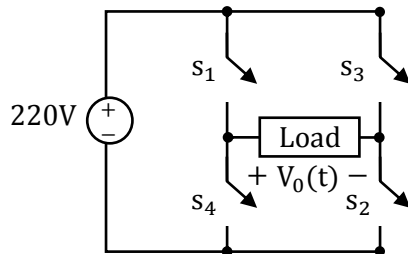

The RMS value of the fundamental component of $V_o(t)$ in volts is _____

[Ans. *] Range: 196 to 200

Given circuit is 1 - phase full bridge voltage source inverter. It is mentioned that output voltage is a square wave and its amplitude will be 220 V

Therefore, RMS value of fundamental component of output voltage

$$= \frac{2\sqrt{2}}{\pi} V_{dc} = \frac{2\sqrt{2}}{\pi} \times 220 = 198.07 \text{ V}$$

7. Let $I = c \iint_R xy^2 \, dx dy$, where R is the region shown in the figure and $c = 6 \times 10^{-4}$. The value of I equals _____. (Give the answer up to two decimal places)

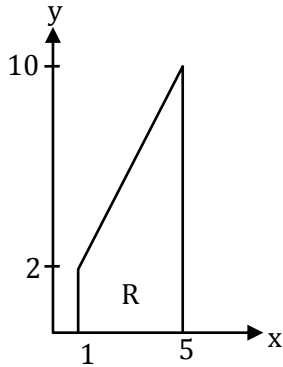

[Ans. *] Range: 0.99 to 1.01

Let $I = c \iint_R XY^2 dx dy \dots \dots \dots \textcircled{1}$

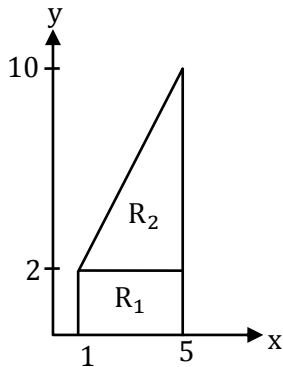

Now,

$$\begin{aligned} \iint_R XY^2 dXdY &= \iint_{R_1} XY^2 dx dy + \iint_{R_2} XY^2 dx dy \\ &= \int_0^2 \int_1^5 XY^2 dx dy + \int_2^{10} \int_{y/2}^5 XY^2 dx dy \\ &= \int_0^2 \left(\frac{X^2}{2}\right)_1^5 Y^2 dy + \int_2^{10} \left(\frac{X^2}{2}\right)_{y/2}^5 y^2 dy \\ &= \int_0^2 \left(\frac{25}{2} - \frac{1}{2}\right) y^2 dy + \int_2^{10} \left(\frac{25}{2} - \frac{y^2}{8}\right) y^2 dy \\ &= 12 \int_0^2 y^2 dy + \int_2^{10} \left(\frac{25y^2}{2} - \frac{y^4}{8}\right) dy \\ &= 12 \left(\frac{y^3}{3}\right)_0^2 + \int_2^{10} \left(\frac{25y^2}{2} - \frac{y^4}{8}\right) dy \\ &= 32 + \left(\frac{25y^3}{6} - \frac{y^5}{40}\right)_2^{10} \\ &= 32 + \left(\frac{25000}{6} - \frac{10^5}{40}\right) - \left(\frac{200}{6} - \frac{32}{40}\right) \\ &= 1666.13 \end{aligned}$$

$$\therefore I = 0.9996$$

8. For a complex number z ,

$$\lim_{z \rightarrow i} \frac{z^2 + 1}{z^3 + 2z - i(z^2 + 2)}$$
 is

- (A) $-2i$
(B) $-i$
(C) i
(D) $2i$

[Ans. D]

$$\lim_{z \rightarrow i} \frac{z^2 + 1}{z^3 + 2z - i(z^2 + 2)} \quad \left(\frac{0}{0} \text{ form} \right)$$

Applying L Hospital rule

$$= \lim_{z \rightarrow i} \frac{2z}{3z^2 + 2 - i(2z)}$$

$$= \frac{2(i)}{3(-1) + 2 - i(2i)} = \frac{2i}{-3 + 2 + 2} = 2i$$

9. A solid iron cylinder is placed in a region containing a uniform magnetic field such that the cylinder axis is parallel to the magnetic field direction. The magnetic field lines inside the cylinder will
- (A) bend closer to the cylinder axis
(B) bend farther away from the axis
(C) remain uniform as before
(D) cease to exist inside the cylinder

[Ans. A]

Iron is a ferrormagnetic material.

In such a material, there will be magnetic dipoles associated with the spins of unpaired electrons, just like in a paramagnetic material.

In the absence of any external magnetic field:

In a paramagnetic material these dipoles are oriented in all possible directions, and so their dipole moments are cancelled out, and the material as a whole is non-magnetic.

In a ferromagnetic material, all the dipoles point in only one direction. (This can be explained using quantum mechanics).

But in that case, every nail, every piece of iron, must be a powerful permanent magnet; why is it not so?

The alignment occurs in small patches, called domains. Each domain has several billions of dipoles, all pointing in one direction; but in any small piece of iron, there are billions of such domains, dipoles of each domain oriented randomly in some direction. The net magnetization of all these dipoles is zero.

When an external magnetic field \vec{B}_{ext} is applied, domains with the same direction as \vec{B}_{ext} grow, others shrink; the material is magnetized in the direction of \vec{B}_{ext} .

So when a solid iron cylinder is placed in a uniform \vec{B}_{ext} with the axis of the cylinder along the direction of \vec{B}_{ext} , the field lines in the cylinder remain parallel and uniform as before, but their density increases.

10. The slope and level detector circuit in a CRO has a delay of 100 ns. The start-stop sweep generator has a response time of 50 ns. In order to display correctly, a delay line of
- (A) 150 ns has to be inserted into the y-channel
 - (B) 150 ns has to be inserted into the x-channel
 - (C) 150 ns has to be inserted into both x and y channels
 - (D) 100 ns has to be inserted into both x and y channels

[Ans. A]

In order to display correctly, a delay line of 150 ns has to be inserted in to the Y-channel between output of vertical amplifier and Y-input of CRT

11. Consider $g(t) = \begin{cases} t - [t], & t \geq 0 \\ t - [t], & \text{otherwise} \end{cases}$,

where $t \in \mathbb{R}$

Here, $[t]$ represent the largest integer less than or equal to t and $[t]$ denotes the smallest integer greater than or equal to t . The coefficient of the second harmonic component of the Fourier series representing $g(t)$ is _____

[Ans. *] Range: 0 to 0

Given $g(t) = \begin{cases} t - [t], & t \geq 0 \\ t - [t], & \text{otherwise} \end{cases}$

If we plot the above signal, we get

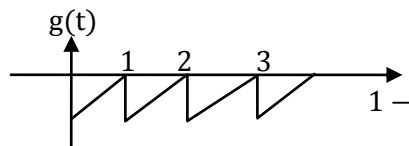

Since this wave form contain hidden half wave symmetry, even harmonics does not exist. Thus coefficient of second harmonic component of Fourier series will be zero.

12. A 3-phase voltage source inverter is supplied from a 600 V DC source as shown in the figure below. For a star connected resistive load of 20 Ω per phase, the load power for 120° device conduction, in kW, is _____

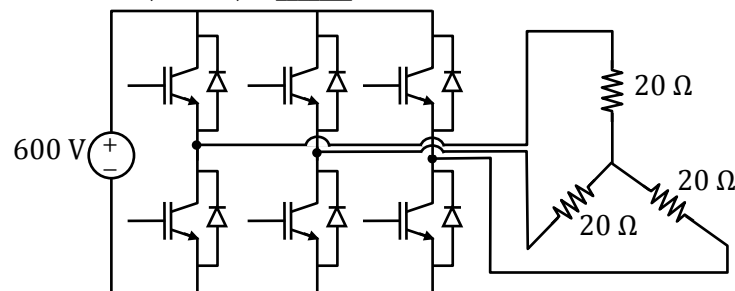

[Ans.*] Range: 8.5 to 9.5

RMS value of phase voltage for 120° conduction mode is $V_{ph} = \frac{V_{dc}}{\sqrt{6}} = \frac{600}{\sqrt{6}} V$

$$\begin{aligned} \text{Power delivered to load } P_0 &= 3 \times \frac{V_{ph}^2}{R} \\ &= 3 \times \frac{\left(\frac{600}{\sqrt{6}}\right)^2}{20} = 9\text{kW} \end{aligned}$$

13. Let $z(t) = x(t) * y(t)$. Where “ $*$ ” denotes convolution. Let c be a positive real-valued constant. Choose the correct expression for $z(ct)$
- (A) $c \cdot x(ct) * y(ct)$
 (B) $x(ct) * y(ct)$
 (C) $c \cdot x(ct) * y(ct)$
 (D) $c \cdot x(ct) * y(t)$

[Ans. A]

$z(t) = x(t) * y(t)$ as per property of convolution

$$x(ct) * y(ct) = \frac{1}{|c|} z(ct)$$

$$z(ct) = |c| x(ct) * y(ct)$$

Given ‘ c ’ is a positive integer, so

$$z(ct) = c x(ct) * y(ct)$$

14. For the circuit shown in the figure below, assume that diodes D_1 , D_2 and D_3 are ideal.

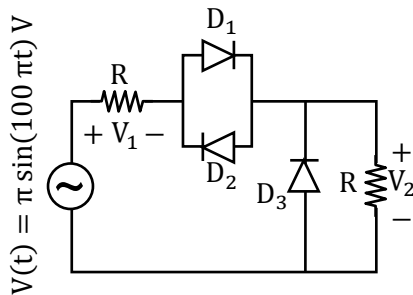

The DC components of voltages v_1 and v_2 , respectively are

- (A) 0 V and 1 V
 (B) -0.5 V and 0.5 V
 (C) 1 V and 0.5 V
 (D) 1 V and 1 V

[Ans. B]

During +ve cycle input:

$D_1 \rightarrow \text{ON}$ D_2 and $D_3 \rightarrow \text{OFF}$

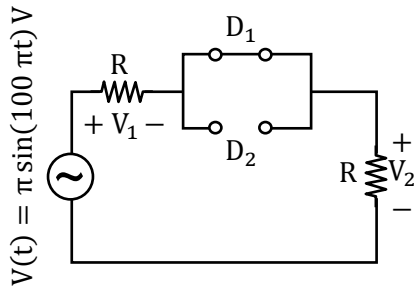

$$V_1 = V_2 = \frac{V(t)}{2}$$

During -ve cycle input:

$D_1 \rightarrow \text{OFF}, D_2 \text{ and } D_3 \rightarrow \text{ON}$

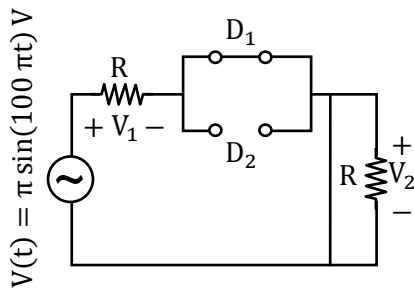

$$V_2 = 0 \text{ and } V_1 = V(t)$$

The voltage waveforms are shown in below figure.

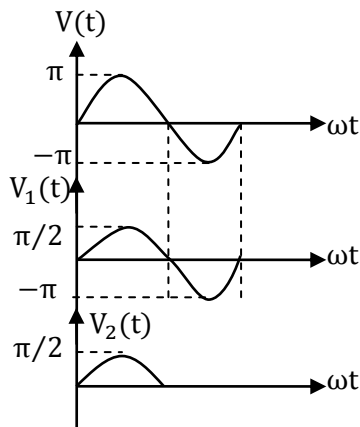

$$\begin{aligned} \text{DC component of } V_1 \text{ is } &= \frac{V_{m1}}{\pi} + \frac{V_{m2}}{\pi} \\ &= \frac{\pi/2}{\pi} + \frac{-\pi}{\pi} \Rightarrow -0.5V \end{aligned}$$

$$\text{DC component of } V_2 \text{ is } = \frac{\pi/2}{\pi} \Rightarrow 0.5V$$

15. For the power semiconductor devices IGBT, MOSFET, Diode and Thyristor, which one of the following statements is TRUE?
- (A) All the four are majority carrier devices
- (B) All the four are minority carrier devices

- (C) IGBT and MOSFET are majority carrier devices, whereas Diode and Thyristor are minority carrier devices.
 (D) MOSFET is majority carrier device, whereas IGBT, Diode, Thyristor are minority carrier devices.

[Ans. D]

Only MOSFET is majority carrier device. And remaining all other devices belongs to minority carrier devices

16. Consider the system with following input-output relation $y[n] = (1 + (-1)^n)x[n]$
 Where, $x[n]$ is the input and $y[n]$ is the output. The system is
 (A) Invertible and time invariant
 (B) Invertible and time varying
 (C) Non-invertible and time invariant
 (D) Non-invertible and time varying

[Ans. D]

$y(n) = [1 + (-1)^n]x(n)$
 $Y_1(n) = [1 + (-1)^n]x(n - n_0)$
 $y(n - n_0) = [1 + (-1)^{n-n_0}]x(n - n_0)$
 $y_1(n) \neq y(n - n_0)$; so, time variant
 if $x_1(n) = u(n)$
 $\Rightarrow y_1(n) = [1 + (-1)^n]u(n)$
 $= [2, 0, 2, 0, 2, 0, \dots \dots]$
 $x_2(n) = [1, 0, 1, 0, 1, 0, \dots \dots]$
 $\Rightarrow y_2(n) = [1 + (-1)^n]x_2(n) = [2, 0, 2, 0, \dots \dots]$
 Non-invertible, variant
 The system is time variant and non-invertible.

17. A three-phase, 50 Hz, star-connected cylindrical-rotor synchronous machine is running as a motor. The machine is operated from a 6.6 kV grid and draws current at unity power factor (UPF). The synchronous reactance of the motor is 30Ω per phase. The load angle is 30° . The power delivered to the motor in kW is _____ (Give the answer up to one decimal place)

[Ans. *] Range: 8.35 to 8.42

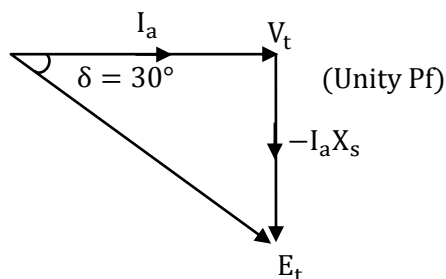

By neglecting armature resistance the active power drawn by a synchronous motor is

$$p = 3 \times \frac{E_t V_t}{X_s} \sin \delta$$

$$\Rightarrow E_t = \sqrt{V_t^2 + (I_a X_s)^2}; V_t = \frac{6600}{\sqrt{3}} \text{ V/Ph}$$

$$\cos\delta = \frac{V_t}{E_t} \Rightarrow E_t = \frac{V_t}{\cos\delta} = (6.6/\sqrt{3}) \times \frac{1000}{\cos(30)}$$

$$E_t = 4400 \text{ V/ph}$$

$$\Rightarrow P = (3) \left[\frac{4400 \times \frac{6600}{\sqrt{3}}}{30} \right] \sin(30)$$

$$P=838.31 \text{ kW}$$

18. A source is supplying a load through a 2-phase, 3-wire transmission system as shown in figure below. The instantaneous voltage and current in phase-a are $v_{an} = 220 \sin(100\pi t)$ V and $i_a = 10 \sin(100\pi t)$ A respectively. Similarly for phase-b, the instantaneous voltage and current are $v_{bn} = 220 \cos(100\pi t)$ V and $i_b = 10 \cos(100\pi t)$ A, respectively.

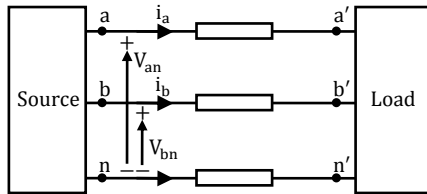

The total instantaneous power flowing from the source to the load is

- (A) 2200 W
 (B) $2200 \sin^2(100\pi t)$ W
 (C) 4400 W
 (D) $2200 \sin(100\pi t) \cos(100\pi t)$ W

[Ans. A]

Total instantaneous power:

$$s_T^* = V_{an}^* I_a^* + V_{bn}^* I_b^*$$

$$\left[\frac{220}{\sqrt{2}} \angle 0^\circ \right] \left[\frac{10}{\sqrt{2}} \angle 0^\circ \right] + \left[\frac{220}{\sqrt{2}} \angle 90^\circ \right] \left[\frac{10}{\sqrt{2}} \angle 90^\circ \right]$$

$$= 1100 + 1100 = 2200 \text{ W}$$

19. A closed loop system has the characteristic equation given by $s^3 + Ks^2 + (K + 2)s + 3 = 0$. For this system to be stable, which one of the following conditions should be satisfied?

- (A) $0 < K < 0.5$
 (B) $0.5 < K < 1$
 (C) $0 < K < 1$
 (D) $K > 1$

[Ans. D]

$$\begin{array}{l|ll} s^3 & 1 & K + 2 \\ s^2 & K & 3 \\ s^1 & K^2 + 2K - 3 & \\ s^0 & K & 3 \end{array}$$

For stability $K > 0$ and $K^2 + 2K - 3 > 0$

So, $K^2 + 2K - 3 > 0 \Rightarrow$ i. e $K > 1$

20. The transfer function of a system is given by

$$\frac{V_o(s)}{V_i(s)} = \frac{1-s}{1+s}$$

Let the output of the system be $v_o(t) = V_m \sin(\omega t + \phi)$ for the input $v_i(t) = V_m \sin(\omega t)$. Then the minimum and maximum values of ϕ (in radians) are respectively

- (A) $-\frac{\pi}{2}$ and $\frac{\pi}{2}$
 (B) $-\frac{\pi}{2}$ and 0
 (C) 0 and $\frac{\pi}{2}$
 (D) $-\pi$ and 0

[Ans. D]

$$\angle \left(\frac{1-j\omega}{1+j\omega} \right) = \angle (-\tan^{-1}\omega - \tan^{-1}\omega)$$

At $\omega = 0, \phi = 0^\circ$ (Maximum)

At $\omega = \infty, \phi = -180^\circ$ (Minimum)

21. A 10 bus power system consists of four generator buses indexed as G1, G2, G3, G4 and six load buses indexed as L1, L2, L3, L4, L5, L6. The generator-bus G1 is considered as slack bus, and the load buses L3 and L4 are voltage controlled buses. The generator at bus G2 cannot supply the required reactive power demand, and hence it is operating at its maximum reactive power limit. The number of non-linear equations required for solving the load flow problem using Newton-Raphson method in polar form is _____.

[Ans. *] Range: 14 to 14

G₁ – Slack bus

G₂ – having reactive power

$$Q_{2\min} \leq Q_2 \leq Q_{2\max}$$

When it is operating at Q₂ max means there is a reactive power divergent. Hence it is working as load bus.

G₂ → 2 equations

G₃ → 1 equation

G₄ → 1 equation

L₁ → 2 equations

L₂ → 2 equations

L₅ → 2 equations

L₆ → 2 equations

L₃ → 1 equation

L₄ → 1 equation

Total Number of equations are 14

22. Consider the unity feedback control system shown. The value of K that results in a phase margin of the system to be 30° is _____. (Give the answer up to two decimal places).

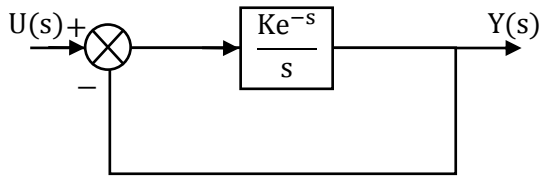

[Ans. *] Range: 1.01 to 1.06

$$PM = 180^\circ + \angle \frac{Ke^{-j\omega_{gc}}}{j\omega_{gc}} = 30^\circ$$

$$\text{And } \left| \frac{Ke^{-j\omega_{gc}}}{j\omega_{gc}} \right| = 1$$

$$\Rightarrow \frac{K}{\omega_{gc}} = 1$$

$$\Rightarrow \omega_{gc} = K$$

$$PM = 180^\circ - \omega_{gc} - 90^\circ = 30^\circ$$

$$\Rightarrow \omega_{gc} = 60^\circ = \frac{\pi}{3} = 1.05$$

23. A 4 pole induction machine is working as an induction generator. The generator supply frequency is 60 Hz. The rotor current frequency is 5 Hz. The mechanical speed of the rotor in RPM is
- (A) 1350
(B) 1650
(C) 1950
(D) 2250

[Ans. C]

Supply frequency (f_1) = 60 Hz & Pole = 4

$$\therefore N_s = \frac{120f}{P} = \frac{120 \times 60}{4} = 1800 \text{rpm}$$

Rotor frequency (f_2) = 5 Hz

We know that $f_2 = sf_1$

$$5 = (s)(60) \Rightarrow 0.0833$$

But in induction generator, slip is a negative value

$$\Rightarrow -0.0833 = \frac{1800 - N_r}{1800}$$

$$\Rightarrow N_r = 1950 \text{rpm}$$

24. The Boolean expression $AB + A\bar{C} + BC$ simplifies to
- (A) $BC + A\bar{C}$
(B) $AB + A\bar{C} + B$
(C) $AB + A\bar{C}$
(D) $AB + BC$

[Ans. A]

$$\begin{aligned} AB + A\bar{C} + BC &= AB(C + \bar{C}) + A\bar{C} + BC \\ &= ABC + AB\bar{C} + A\bar{C} + BC \\ &= BC(A + 1) + A\bar{C}(B + 1) \end{aligned}$$

$$= A\bar{C} + BC$$

25. The power supplied by the 25 V source in the figure shown below is _____ W.

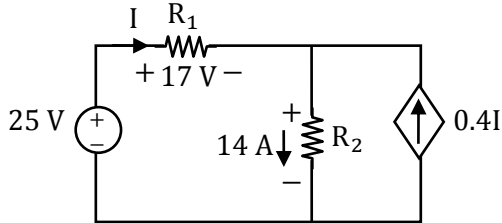

[Ans. *] Range: 248 to 252

From KCL,

$$I + 0.4I = 14$$

$$1.4I = 14$$

$$\Rightarrow I = 10 \text{ A}$$

$$\text{So, power supplied} = 25 \times 10 = 250 \text{ W}$$

26. The figure below shows an uncontrolled diode bridge rectifier supplied from a 220 V, 50 Hz, 1-phase ac source. The load draws a constant $I_o = 14 \text{ A}$. The conduction angle of the diode D_1 in degrees (rounded off to two decimal places) is

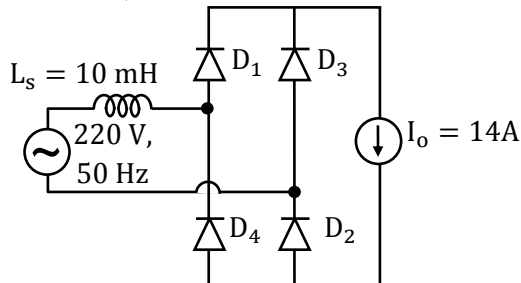

[Ans. *] Range: 220 to 230

When source inductance is not taken into account, each diode will conduct for 180°

When source inductance is taken into account, each diode will conduct for $(180 + \mu)^\circ$

Where μ is overlap angle and can be determined as follows:

$$\cos \mu = 1 - \frac{2\omega L_s}{V_m} I_o$$

$$\Rightarrow \cos \mu = 1 - \frac{2 \times 100\pi \times 10 \times 10^{-3}}{220\sqrt{2}} \times 14 = 0.71727$$

$$\Rightarrow \mu = 44.17^\circ$$

$$\therefore \text{Conduction angle for } D_1 \text{ is } 180 + 44.17 = 224.17^\circ$$

27. The transfer function of the system $Y(s)/U(s)$ whose state-space equations are given below is:

$$\begin{bmatrix} \dot{x}_1(t) \\ \dot{x}_2(t) \end{bmatrix} = \begin{bmatrix} 1 & 2 \\ 2 & 0 \end{bmatrix} \begin{bmatrix} x_1(t) \\ x_2(t) \end{bmatrix} + \begin{bmatrix} 1 \\ 2 \end{bmatrix} u(t)$$

$$y(t) = \begin{bmatrix} 1 & 0 \end{bmatrix} \begin{bmatrix} x_1(t) \\ x_2(t) \end{bmatrix}$$

(A) $\frac{(s+2)}{(s^2-2s-2)}$

(B) $\frac{(s - 2)}{(s^2 + s - 4)}$

(C) $\frac{(s - 4)}{(s^2 + s - 4)}$

(D) $\frac{(s + 4)}{(s^2 - s - 4)}$

[Ans. D]

TF = C[SI - A]⁻¹B

SI - A = $\begin{bmatrix} s - 1 & -2 \\ -2 & s \end{bmatrix}$

TF = $\frac{[1 \ 0] \begin{bmatrix} s & 2 \\ 2 & s - 1 \end{bmatrix} \begin{bmatrix} 1 \\ 2 \end{bmatrix}}{(s - 1)(s) - 4}$

TF = $\frac{s + 4}{s^2 - s - 4}$

28. A function f(x) is defined as

$f(x) = \begin{cases} e^x, & x < 1 \\ \ln x + ax^2 + bx, & x \geq 1 \end{cases}$

Where x ∈ R. Which one of the following statements is TRUE?

- (A) f(x) is NOT differentiable at x = 1 for any values of a and b
- (B) f(x) is differentiable at x = 1 for the unique values of a and b
- (C) f(x) is differentiable at x = 1 for all values of a and b such that a + b = e
- (D) f(x) is differentiable at x = 1 for all values of a and b

[Ans. B]

$f(x) = \begin{cases} e^x, & x < 1 \\ \log x + ax^2 + bx, & x \geq 1 \end{cases}$

$f'(x) = \begin{cases} e^x, & x < 1 \\ \frac{1}{x} + 2ax + b, & x \geq 1 \end{cases}$

At x=1,

L H D = e, R H D = 1 + 2a + b

Since f(x) is differentiable at x = 1,

1 + 2a + b = e ⇒ 2a + b = e - 1 ①

Since f(x) is continuous at x = 1,

At x = 1,

L H L = e

R H L = a + b

⇒ a + b = e ②

Solving ① and ②

a = -1

b = e + 1

∴ a and b have unique values.

29. The approximate transfer characteristic for the circuit shown below with an ideal operational amplifier and diode will be

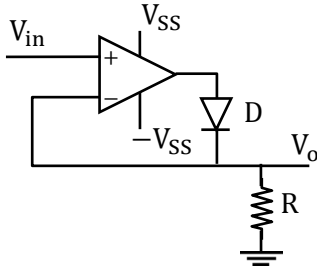

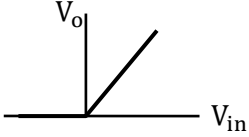
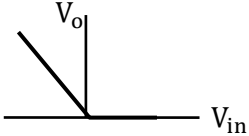
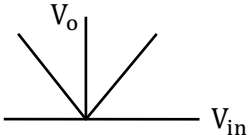
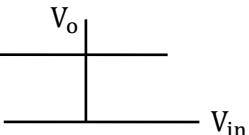
- (A) 
- (B) 
- (C) 
- (C) 

[Ans. A]

The given circuit is redrawn as

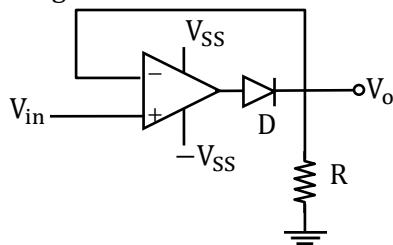

When $V_{in} > 0$, Diode is ON, then replaced by SC

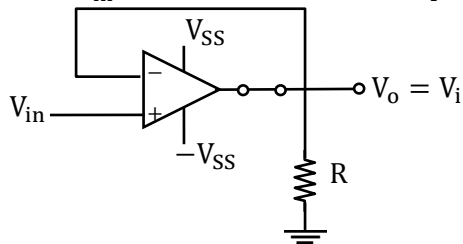

When $V_{in} < 0$, Diode OFF, then replaced by OC

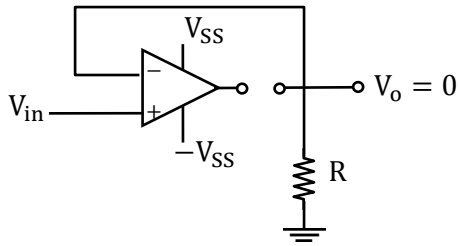

The output characteristic is shown below.

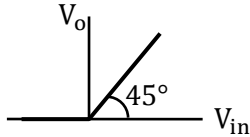

30. In the circuit shown below, the maximum power transferred to the resistor R is ____ W.

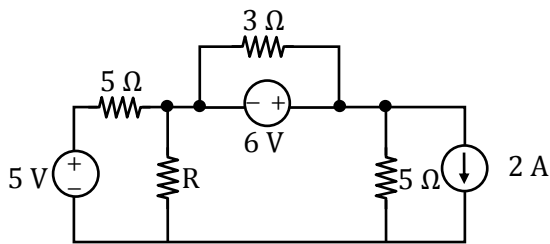

[Ans. *] Range: 3 to 3.1

To find V_{Th} :

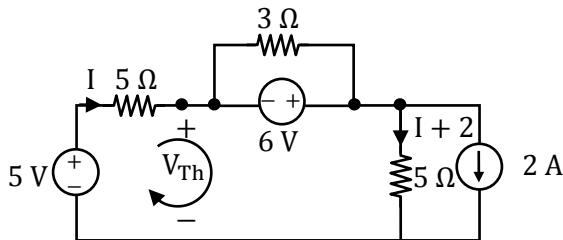

By applying KVL to the above loop

$$-5 + 5I - 6 + 5(I + 2) = 0$$

$$I = 2.1$$

$$V_{Th} = 5 - 2.1 \times 5 = -5.5$$

To find R_{Th} :

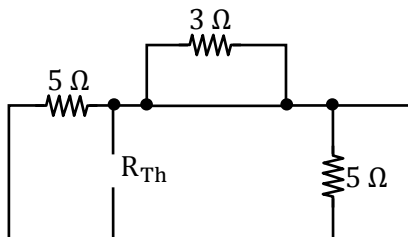

$$R_{Th} = 2.5$$

Maximum power transferred is

$$\frac{V_{Th}^2}{4R_{Th}} = \frac{(5.5)^2}{4(2.5)} = 3.025$$

$$\therefore \text{Maximum power transferred} = 3.025$$

31. A separately excited DC generator supplies 150 A to a 145 V DC grid. The generator is running at 800 RPM. The armature resistance of the generator is 0.1Ω . If the speed of the generator is increased to 1000 RPM, the current in amperes supplied by the generator to the DC grid is _____.

[Ans. *] Range: 548 to 552

$$V_t = 145 \text{ V (Grid)}$$

$$I_{a1} = 150 \text{ A}; N_1 = 800 \text{ rpm}$$

$$R_a = 0.1\Omega$$

$$N_2 = 1000\text{rpm}; V_{t2} = 145 \text{ V(Grid)}$$

$$I_{a2} = ?$$

$$\Rightarrow E_{g1} = V_t + I_{a1}r_a$$

$$= 145 + (150)(0.1) = 160\text{V}$$

$$\frac{E_{g1}}{E_{g2}} = \frac{N_1}{N_2} \quad [\because E_g = K_a\phi\omega, \phi = \text{const}]$$

$$E_{g2} = \left(\frac{1000}{800}\right)(160)$$

$$= 200\text{V}$$

$$\Rightarrow I_{a2} = \frac{200 - 145}{0.1} = 550\text{A}$$

$$I_{a2} = 550\text{A}$$

32. Consider a causal and stable LTI system with rotational transfer function $H(z)$, whose corresponding impulse response begins at $n = 0$. Furthermore, $H(1) = \frac{5}{4}$. The poles of $H(z)$ are $p_k = \frac{1}{\sqrt{2}} \exp\left(j\frac{2k-1\pi}{4}\right)$ for $k = 1, 2, 3, 4$. The zeros of $H(z)$ are all at $z = 0$. Let $g[n] = j^n h[n]$. The value of $g[8]$ equals _____ (Give the answer up to three decimal places).

[Ans. *] Range: 0.06 to 0.065

33. The magnitude of magnetic flux density (B) in micro Teslas (μT), at the center of a loop of wire wound as a regular hexagon of side length 1 m carrying a current ($I = 1\text{A}$) and placed in vacuum as shown in the figure is _____.

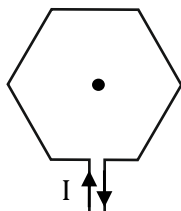

[Ans. *] Range: 0.65 to 0.75

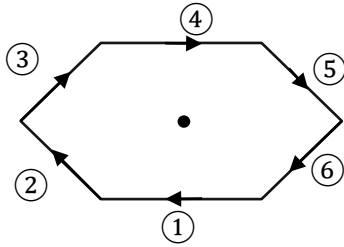

$$H = H_1 + H_2 + H_3 + H_4 + H_5 + H_6$$

Since the figure is regular hexagon, the field magnitude is same and is in the same direction

$$\text{So, } H = 6H_1$$

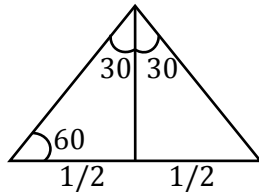

$$\tan 60 = \frac{d}{\frac{1}{2}}$$

$$\sqrt{3} = 2d$$

$$d = \frac{\sqrt{3}}{2}$$

$$H_1 = \frac{I}{4\pi d} (\sin \alpha_1 + \sin \alpha_2)$$

$$H_1 = \frac{1}{4\pi \left(\frac{\sqrt{3}}{2}\right)} \left(\frac{1}{2} + \frac{1}{2}\right)$$

$$H_1 = \frac{1}{2\sqrt{3}\pi}$$

$$H = 6H_1 = \frac{\sqrt{3}}{\pi}$$

$$B = \mu_0 H = 4\pi \times 10^{-7} \frac{\sqrt{3}}{\pi} = 4\sqrt{3} \times 10^{-7}$$

$$B = 0.693 \mu\text{T}$$

34. For a system having transfer function $G(s) = \frac{-s+1}{s+1}$ a unit step input is applied at time $t = 0$.

The value of the response of the system at $t = 1.5$ sec (rounded off to three decimal places) is

[Ans. *] Range: 0.550 to 0.556

$$\text{TF} = \frac{1-s}{1+s} \quad \text{Input} = \frac{1}{s} \text{ (unit step)}$$

$$\text{Output} = (\text{TF})(\text{input})$$

$$= \left(\frac{1-s}{1+s}\right) \frac{1}{s}$$

$$\text{Output} = L^{-1} \left[\frac{1}{s} \times \frac{1-s}{1+s} \right]$$

$$= 1 - 2e^{-t}$$

$$\text{Output at } (t = 1.5) = 1 - 2e^{-1.5}$$

$$= 0.554$$

35. Consider the differential equation $(t^2 - 81)\frac{dy}{dt} + 5ty = \sin(t)$ with $y(1) = 2\pi$. There exists a unique solution for this differential equation when t belongs to the interval
- (A) $(-2, 2)$
 (B) $(-10, 10)$
 (C) $(-10, 2)$
 (D) $(0, 10)$

[Ans. A]

$$(t^2 - 81)\frac{dy}{dt} + 5ty = \sin t \text{ with } y(1) = 2\pi$$

$$\frac{dy}{dt} + \frac{5t}{(t^2 - 81)}y = \frac{\sin t}{(t^2 - 81)}$$

The given differential equation has no solution when $t = \pm 9$. These values do not lie in the interval $(-2, 2)$. The solution of the given differential equation lies in the interval $(-2, 2)$.

\therefore Option (A) is correct

36. Consider the line integral $I = \int_c (x^2 + iy^2) dz$, where $z = x + iy$. The line c is shown in the figure below.

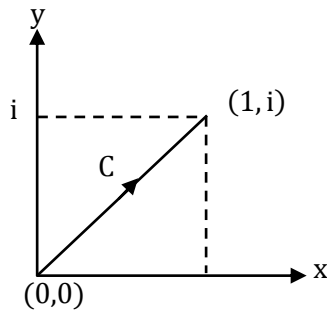

The value of I is

- (A) $\frac{1}{2}i$
 (B) $\frac{2}{3}i$
 (C) $\frac{3}{4}i$
 (D) $\frac{4}{5}i$

[Ans. B]

Given C is $y = x$

$$\Rightarrow dy = dx$$

Then x varies from 0 to 1

$$I = \int_c (x^2 + iy^2) dz$$

$$= \int_0^1 (x^2 + ix^2)(dx + idx)$$

$$= (1 + i)^2 \int_0^1 x^2 dx = (1 + 2i + i^2) \left[\frac{x^3}{3} \right]_0^1$$

$$= (1 + 2i - 1) \left(\frac{1}{3} \right) = \frac{2i}{3}$$

37. The input voltage V_{DC} of the buck-boost converter shown below varies from 32 V to 72 V. Assume that all components are ideal, inductor current is continuous, and output voltage is ripple free. The range of duty ratio D of the converter for which the magnitude of the steady-state output voltage remains constant at 48 V is

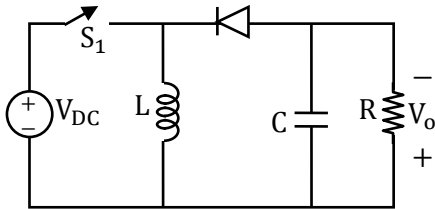

- (A) $\frac{2}{5} \leq D \leq \frac{3}{5}$
 (B) $\frac{2}{5} \leq D \leq \frac{3}{4}$
 (C) $0 \leq D \leq 1$
 (D) $\frac{1}{3} \leq D \leq \frac{2}{3}$

[Ans. A]

In Buck boost converter, $V_o = \frac{D}{1-D} V_{dc}$

When $V_{dc} = 32V$, $\frac{D}{1-D} = \frac{48}{32} \Rightarrow D = \frac{3}{5} = 0.6$

When $V_{dc} = 72V$, $\frac{D}{1-D} = \frac{48}{72} \Rightarrow D = \frac{2}{5} = 0.4$

\therefore The range of D will be $\frac{2}{5} \leq D \leq \frac{3}{5}$ or $0.4 \leq D \leq 0.6$

38. The load shown in the figure is supplied by a 400 V (line-to-line) 3-phase source (RYB sequence). The load is balanced and inductive, drawing 3464 VA. When the switch S is in position N , the three watt-meters W_1 , W_2 and W_3 read 577.35 W each. If the switch is moved to position Y , the readings of the watt-meters in watts will be:

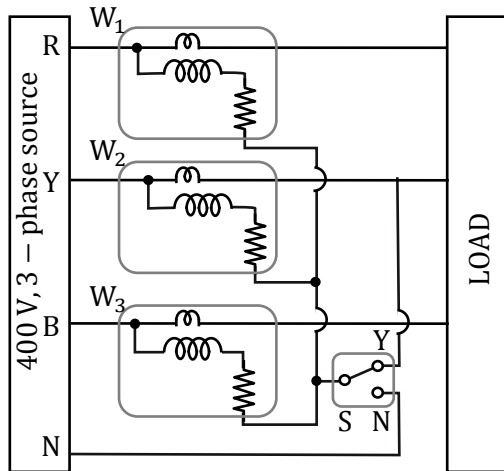

- (A) $W_1 = 1732$ and $W_2 = W_3 = 0$
 (B) $W_1 = 0, W_2 = 1732$ and $W_3 = 0$
 (C) $W_1 = 866, W_2 = 0, W_3 = 866$
 (D) $W_1 = W_2 = 0$ and $W_3 = 1732$

[Ans. D]

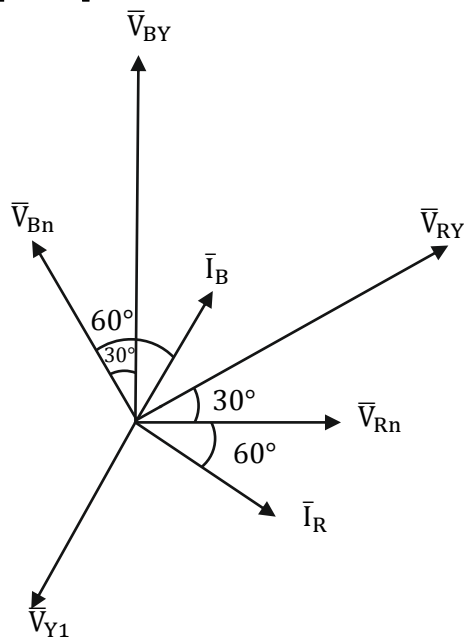

$$P = W_1 + W_2 + W_3 = 1732.05$$

$$\text{Power factor, } \cos \phi = \frac{1732.05}{3464} = 0.5 \text{ lag}$$

$$\sqrt{3} \times 400 \times I_L \times 0.5 = 1732.05$$

$$I_L = \frac{1732.05}{\sqrt{3} \times 400 \times 0.5} = 5 \text{ A}$$

When switch is in position N

$$W_1 = W_2 = W_3 = 577.35 \text{ W} \Rightarrow \text{balanced load}$$

\therefore total power consumed by load is

$$W = W_1 + W_2 + W_3$$

$$W = 1732.05 \text{ W}$$

Given load is inductive

And VA draw from source = 3464 VA

$$\begin{aligned} \therefore \text{Power factor} &= \frac{W}{VA} \\ &= \frac{1732.05}{3464} \\ &= 0.5 \text{ lag} \end{aligned}$$

⇒ power factor angle = -60° (\because lag)

When switch is connected in Y position pressure coil of W_2 is shorted So $W_2 = 0$ and phasor diagrams for other two are as follows

$$\begin{aligned} W_1 &= V_{RY} I_R \cos(\text{angle between } \bar{V}_{RY} \text{ and } \bar{I}_R) \\ &= 400 \times 5 \times \cos(90^\circ) \\ &= 0W \end{aligned}$$

$$\begin{aligned} W_3 &= V_{BY} I_B \cos(\text{angle between } \bar{V}_{BY} \text{ and } \bar{I}_B) \\ &= 400 \times 5 \times \cos(30^\circ) \\ &= 400 \times 5 \times \frac{\sqrt{3}}{2} = 1732W \end{aligned}$$

$$W_1 = 0, W_2 = 0, W_3 = 1732 W$$

39. The circuit shown in the figure uses matched transistors with a thermal voltage $V_T = 25 \text{ mV}$. The base currents of the transistors are negligible. The value of the resistance R in $k\Omega$ that is required to provide $1 \mu\text{A}$ bias current for the differential amplifier block shown is _____.

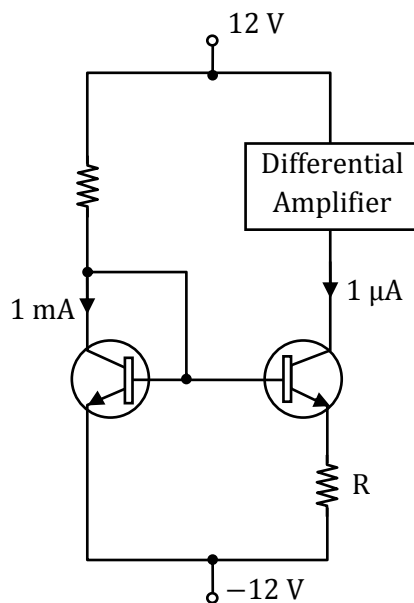

[Ans. *] Range: 170 to 174

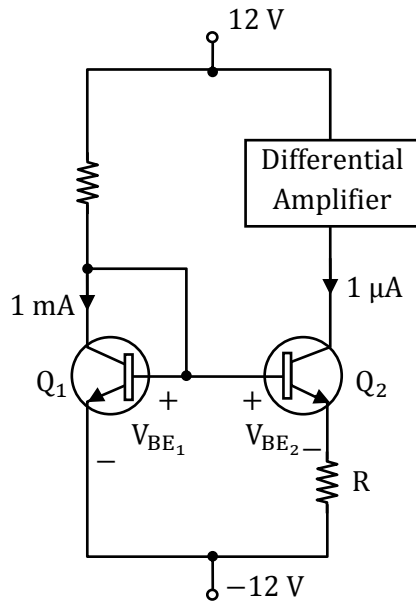

$$I_{C_1} = 1\text{mA}, I_{C_2} = 1\mu\text{A}$$

As B&C shorted, Transistor behaves as diode.

$$I_B = 0, I_C = I_E$$

Then,

$$I_{C_1} = I_0 \cdot e^{V_{BE_1}/V_T}$$

$$I_{C_2} = I_0 \cdot e^{V_{BE_2}/V_T}$$

$$\frac{I_{C_1}}{I_{C_2}} = \frac{I_0 \cdot e^{\frac{V_{BE_1}}{V_T}}}{I_0 \cdot e^{\frac{V_{BE_2}}{V_T}}}$$

$$\frac{I_{C_1}}{I_{C_2}} = e^{(V_{BE_1} - V_{BE_2})/V_T}$$

$$V_{BE_1} - V_{BE_2} = V_T \ln\left(\frac{I_{C_1}}{I_{C_2}}\right)$$

$$\text{And } V_{BE_1} = V_{BE_2} + I_{C_2} \cdot R$$

$$V_{BE_1} - V_{BE_2} = I_{C_2} \cdot R$$

$$R = \frac{V_{BE_1} - V_{BE_2}}{I_{C_2}} = \frac{V_T}{I_{C_2}} \ln\left(\frac{I_{C_1}}{I_{C_2}}\right)$$

$$R = \frac{25 \times 10^{-3}}{10^{-6}} \ln\left(\frac{10^{-3}}{10^{-6}}\right)$$

$$= 25 \times 10^3 \ln(10^3)$$

$$= 172.693\text{k}\Omega$$

$$R = 172.7\text{k}\Omega$$

40. Two parallel connected, three-phase, 50 Hz, 11 kV, star-connected synchronous machines A and B, are operating as synchronous condensers. They together supply 50 MVAR to a 11 kV grid. Current supplied by both the machines are equal. Synchronous reactances of machine A and machine B are 1 Ω and 3 Ω, respectively. Assuming the magnetic circuit to be linear, the

ratio of excitation current of machine A to that of machine B is _____. (Give the answer up to two decimal places).

[Ans. *] Range: 2.05 to 2.13

→ Synchronous Condensers

→ Current's supplied both the machines are same

$$\therefore I_1 = I_2 = \frac{2624.31}{2} = 1312.159 \text{ Amps}$$

As the two motors, supplying reactive power only, the phasor diagram will be

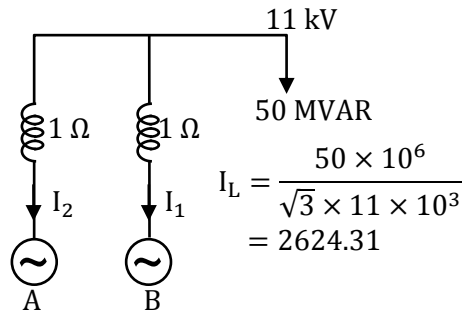

$$E + jI_a X_s = V_t$$

$$E = V - jI_a X_s$$

Consider magnitudes $\Rightarrow E^2 = (V - I_a X_s)^2$

$$E = \sqrt{(V - I_a X_s)^2}$$

$$E_A = \sqrt{(6350.85 - 1312.159 \times 1)^2} = 5038.7 \text{ Volts}$$

$$E_B = \sqrt{(6350.85 - 1312.159 \times 3)^2} = 2414.14 \text{ Volts}$$

$$\frac{I_{fA}}{I_{fB}} = \frac{E_A}{E_B} = \frac{5038.7}{2414.14} = 2.086$$

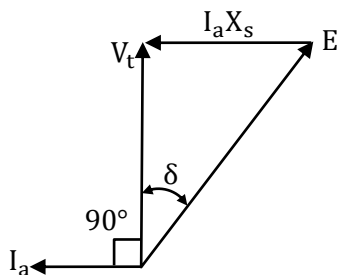

41. The output expression for the Karnaugh map shown below is

		CD			
AB		00	01	11	10
	00	0	0	0	0
	01	1	0	0	1
	11	1	0	1	1
	10	0	0	0	0

- (A) $B\bar{D} + BCD$
- (B) $B\bar{D} + AB$
- (C) $\bar{B}D + ABC$
- (D) $B\bar{D} + ABC$

[Ans. D]

	CD			
	00	01	11	10
AB				
00	0	0	0	0
01	1	0	0	1
11	1	0	1	1
10	0	0	0	0

$\Rightarrow F = B \cdot \bar{D} + A \cdot B \cdot C$

42. The bus admittance matrix for a power system network is

$$\begin{bmatrix} -j39.9 & j20 & j20 \\ j20 & -j39.9 & j20 \\ j20 & j20 & -j39.9 \end{bmatrix} \text{ pu.}$$

There is a transmission line connected between buses 1 and 3, which is represented by the circuit shown in figure.

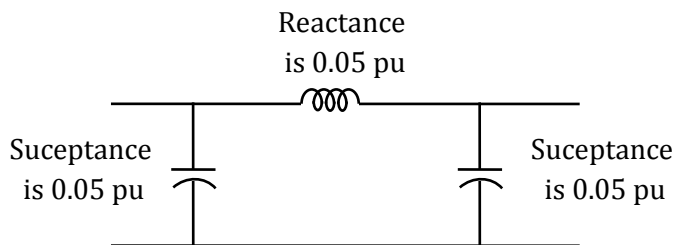

If this transmission line is removed from service what is the modified bus admittance matrix?

- (A) $\begin{bmatrix} -j19.9 & j20 & 0 \\ j20 & -j39.9 & j20 \\ 0 & j20 & -j19.95 \end{bmatrix} \text{ pu}$
- (B) $\begin{bmatrix} -j39.95 & j20 & 0 \\ j20 & -j39.9 & j20 \\ 0 & j20 & -j39.95 \end{bmatrix} \text{ pu}$
- (C) $\begin{bmatrix} -j19.95 & j20 & 0 \\ j20 & -j39.9 & j20 \\ 0 & j20 & -j19.95 \end{bmatrix} \text{ pu}$
- (D) $\begin{bmatrix} -j19.95 & j20 & j20 \\ j20 & -j39.9 & j20 \\ j20 & j20 & -j19.95 \end{bmatrix} \text{ pu}$

[Ans. C]

When the line is removed from buses 1 and 3

$z_{13} = j0.05$

$y_{13} = -j20$

$y_{13} = y_{31} = 0$

$\frac{y'_{13}}{2} = j0.05$ - Half line shunt susceptance

$Y_{11 \text{ mod}} = Y_{11 \text{ old}} - y_{13} - \frac{y'_{13}}{2} = -j39.9 - (-j20) - j0.05 = -j19.95$

$Y_{33 \text{ mod}} = Y_{33 \text{ old}} - y_{31} - \frac{y'_{13}}{2} = -j39.9 - (-j20) - j0.05 = -j19.95$

43. A 375 W, 230 V, 50 Hz, capacitor start single-phase induction motor has the following constants for the main and auxiliary windings (at starting): $Z_m = (12.50 + j15.75)\Omega$ (main winding), $Z_a = (24.50 + j12.75)\Omega$ (auxiliary winding). Neglecting the magnetizing branch, the value of the capacitance (in μF) to be added in series with the auxiliary winding to obtain maximum torque at starting is ____.

[Ans. *] Range: 95 to 100

Given a single-phase capacitor start induction motor

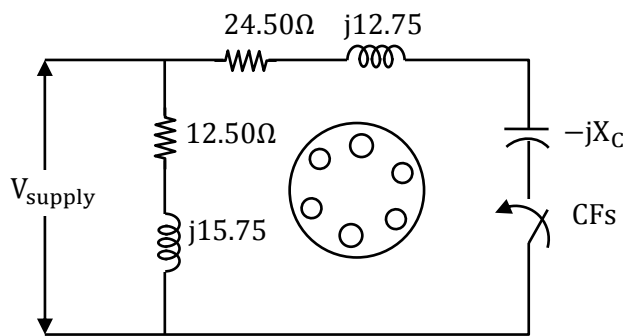

To obtain maximum torque of starting, the main and auxiliary winding currents must have 90° electrical

$$-\tan^{-1}\left(\frac{X_m}{r_m}\right) + \tan^{-1}\left(\frac{X_a - X_c}{r_a}\right) = 90^\circ$$

$$-\tan^{-1}\left(\frac{15.75}{12.5}\right) + \tan^{-1}\left(\frac{12.75 - X_c}{24.50}\right) = 90^\circ$$

$$+12.75 - X_c = -0.79 \times 24.50$$

$$X_c = 32.19\Omega$$

$$\Rightarrow \frac{1}{2\pi f c} = 32.19$$

$$C = \frac{1}{2\pi \times 50 \times 32.19} = 98.8\mu\text{F}$$

44. Two passive two-port networks are connected in cascade as shown in figure. A voltage source is connected at port 1.

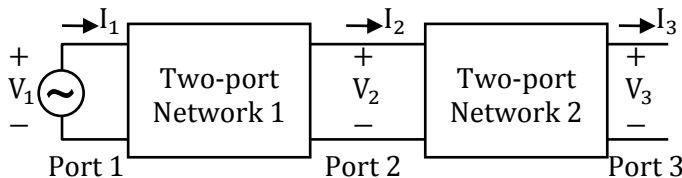

Given:

$$V_1 = A_1 V_2 + B_1 I_2$$

$$I_1 = C_1 V_2 + D_1 I_2$$

$$V_2 = A_2 V_3 + B_2 I_3$$

$$I_2 = C_2 V_3 + D_2 I_3$$

$A_1, B_1, C_1, D_1, A_2, B_2, C_2$ and D_2 are the generalized circuit constants. If the Thevenin equivalent circuit at port 3 consists of a voltage source V_T and an impedance Z_T , connected in series, then

- (A) $V_T = \frac{V_1}{A_1 A_2}, Z_T = \frac{A_1 B_2 + B_1 D_2}{A_1 A_2 + B_1 C_2}$
 (B) $V_T = \frac{V_1}{A_1 A_2 + B_1 C_2}, Z_T = \frac{A_1 B_2 + B_1 D_2}{A_1 A_2}$
 (C) $V_T = \frac{V_1}{A_1 + A_2}, Z_T = \frac{A_1 B_2 + B_1 D_2}{A_1 + A_2}$
 (D) $V_T = \frac{V_1}{A_1 A_2 + B_1 C_2}, Z_T = \frac{A_1 B_2 + B_1 D_2}{A_1 A_2 + B_1 C_2}$

[Ans. D]

$$\begin{bmatrix} V_1 \\ I_1 \end{bmatrix} = \begin{bmatrix} A_1 & B_1 \\ C_1 & D_1 \end{bmatrix} \begin{bmatrix} A_2 & B_2 \\ C_2 & D_2 \end{bmatrix} \begin{bmatrix} V_3 \\ I_3 \end{bmatrix}$$

$$\begin{bmatrix} V_1 \\ I_1 \end{bmatrix} = \begin{bmatrix} A_1 A_2 + B_1 C_2 & A_1 B_2 + B_1 D_2 \\ C_1 A_2 + D_1 C_2 & C_1 B_2 + D_1 D_2 \end{bmatrix} \begin{bmatrix} V_3 \\ I_3 \end{bmatrix}$$

For $Z_{Th}, V_1 = 0$

$$\Rightarrow Z_{Th} = \frac{V_3}{(-I_3)}$$

$$(A_1 A_2 + B_1 C_2)V_3 + (A_1 B_2 + B_1 D_2)I_3 = 0$$

$$\frac{V_3}{I_3} = \frac{-(A_1 B_2 + B_1 D_2)}{A_1 A_2 + B_1 C_2}$$

$$Z_{Th} = \frac{A_1 B_2 + B_1 D_2}{A_1 A_2 + B_1 C_2}$$

For $V_{Th}, V_3 = V_{Th}$ and $I_3 = 0$

$$V_1 = (A_1 A_2 + B_1 C_2)V_{Th}$$

$$\Rightarrow V_T = \frac{V_1}{A_1 A_2 + B_1 C_2}$$

45. Let the signal $x(t) = \sum_{k=-\infty}^{+\infty} (-1)^k \delta\left(t - \frac{k}{2000}\right)$ be passed through an LTI system with frequency response $H(\omega)$, as given in the figure below.

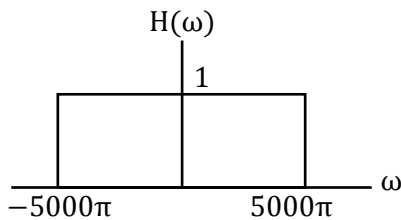

The Fourier series representation of the output is given as

- (A) $4000 + 4000\cos(2000\pi t) + 4000\cos(4000\pi t)$
 (B) $2000 + 2000\cos(2000\pi t) + 2000\cos(4000\pi t)$
 (C) $4000\cos(2000\pi t)$
 (D) $2000\cos(2000\pi t)$

[Ans. C]

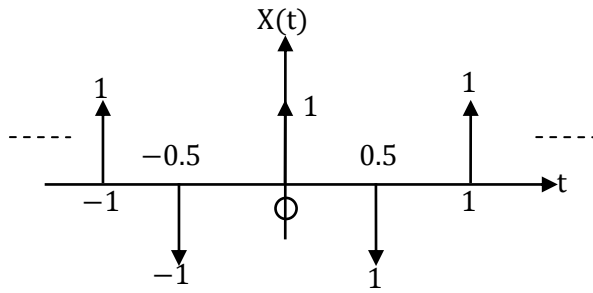

$$C_n = \frac{1}{T_0} \int_0^{T_0} x(t) e^{-jn\omega_0 t} dt$$

$$C_n = \frac{1}{1 \times 10^{-3}} \left[\int_0^1 x(t) e^{-jn\omega_0 t} dt \right]$$

$$C_n = 10^3 [1 - e^{-jn\omega_0 (0.5 \times 10^{-3})}]$$

$$C_n = 10^3 \left[1 - e^{-jn \left(\frac{2\pi}{1 \times 10^{-3}} \right) (0.5 \times 10^{-3})} \right]$$

$$C_n = 10^3 [1 - e^{-jn\pi}] = 1000 [1 - (-1)^n]$$

$$X(\omega) = 2\pi \sum_{n=-\infty}^{\infty} C_n \delta(\omega - n\omega_s)$$

$$X(\omega) = 2000\pi \sum_{n=-\infty}^{\infty} (1 - (-1)^n) \delta(\omega - 2000n\pi)$$

$$X(\omega) = 2000\pi [\dots + 2\delta(\omega + 2000\pi) + 2\delta(\omega - 2000\pi) + \dots]$$

$$X(\omega) = 4000 [\delta(\omega + 2000\pi) + \delta(\omega - 2000\pi) + \dots]$$

$$X(\omega) = 4000 [\cos(2000\pi t) + \cos(6000\pi t) + \dots]$$

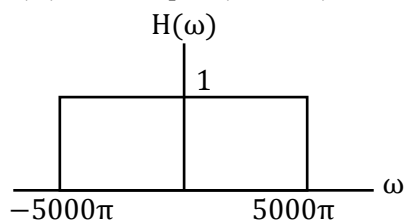

The output of low part filter is

$$y(t) = 4000 \cos(2000\pi t)$$

46. The positive, negative, and zero sequence reactances of a wye-connected synchronous generator are 0.2 pu, 0.2 pu, and 0.1 pu, respectively. The generator is on open circuit with a terminal voltage of 1 pu. The minimum value of the inductive reactance, in pu, required to be connected between neutral and ground so that the fault current does not exceed 3.75 pu if a single line to ground fault occurs at the terminals is ____ (Assume fault impedance to be zero). (Give the answer up to one decimal place)

[Ans. *] Range: 0.1 to 0.1

$$X_1 = j0.2$$

$$X_2 = j0.2$$

$$X_0 = j0.1$$

$$X_F = 0 \text{ (zero fault reactance)}$$

$X_n = ?$

$$L - G \text{ Fault : } I_F = \frac{3E_{R1}}{Z_1 + Z_2 + Z_0 + 3Z_n}$$

$$Z_1 + Z_2 + Z_0 + 3Z_n = \frac{3 \times 1.0}{3.75}$$

$$0.2 + 0.2 + 0.1 + 3Z_n = \frac{3.0}{3.75}$$

$$3Z_n = 0.8 - 0.5$$

$$3Z_n = 0.3$$

$$Z_n = 0.1 \text{ pu}$$

47. The logical gate implemented using the circuit shown below where V_1 and V_2 are inputs (with 0 V as digital 0 and 5 V as digital 1) and V_{OUT} is the output is

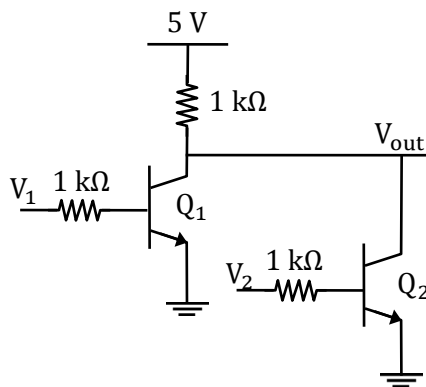

- (A) NOT
(B) NOR
(C) NAND
(D) XOR

[Ans. B]

V_1	V_2	Q_1	Q_2	V_{out}
0	0	OFF	OFF	1
0	1	OFF	ON	0
1	0	ON	OFF	0
1	1	ON	ON	0

$$V_{out} = \overline{V_1 + V_2} \Rightarrow \text{It is a NOR gate}$$

48. A 220 V DC series motor runs drawing a current of 30 A from the supply. Armature and field circuit resistances are 0.4 Ω and 0.1 Ω respectively. The load torque varies as the square of the speed. The flux in the motor may be taken as being proportional to the armature current. To reduce the speed of the motor by 50% the resistance in ohms that should be added in series with the armature is _____. (Give the answer up to two decimal places)

[Ans. *] Range: 9.5 to 12

Given a DC series motor

$$V_t = 220V$$

Before adding extra resistor

$$I_{a1} = 30A$$

$$\begin{aligned} E_{b1} &= V_t - I_{a1}(r_a + r_f) \\ &= 220 - (30)(0.4 + 0.1) \\ &= 205V \end{aligned}$$

After adding extra resistor speed reduced by 50%

$$T \propto N^2; N_2 = 0.5 N_1$$

$$\frac{T_1}{T_2} = \left(\frac{N_1}{N_2}\right)^2$$

$$\frac{T_1}{T_2} = \left(\frac{1}{0.5}\right)^2$$

$$\frac{T_1}{T_2} = 4$$

$$T = Ka\phi I_a; \phi \propto I_a$$

$$\Rightarrow T \propto I_a^2$$

$$\frac{T_1}{T_2} = 4 = \left(\frac{30}{I_{a2}}\right)^2$$

$$I_{a2} = \frac{30}{\sqrt{4}} = 15A$$

$$\Rightarrow E_{b2} = V_t - I_{a2}(r_a + r_f + r_{ex})$$

$$E_{b2} = 220 - 15(0.4 + 0.1 + r_{ex}) \dots \dots \textcircled{1}$$

$$\frac{E_{b1}}{E_{b2}} = \frac{I_{a1}}{I_{a2}} \times \frac{N_1}{N_2}$$

$$\frac{205}{E_{b2}} = \left(\frac{30}{15}\right) \left(\frac{N_1}{0.5N_1}\right)$$

$$E_{b2} = 51.25 \text{ Volts} \dots \dots \textcircled{2}$$

Replace E_{b2} in equation $\textcircled{1}$

$$51.25 = 220 - (15)(0.4 + 0.1 + r_{ex})$$

$$\Rightarrow r_{ex} = 10.75\Omega$$

49. Only one of the real roots of $f(x) = x^6 - x - 1$ lies in the interval $1 \leq x \leq 2$ and bisection method is used to find its value. For achieving an accuracy of 0.001, the required minimum number of iterations is _____.

[Ans. *] Range: 10 to 10

$$f(x) = x^6 - x - 1 \text{ in } [1,2] \text{ we know that } \frac{|b-a|}{2^n} \leq \epsilon$$

$$\Rightarrow \frac{1}{2^n} \leq 0.001$$

$$\Rightarrow 2^n \geq \frac{1}{0.001}$$

$$\Rightarrow 2^n \geq 1000$$

$$\Rightarrow \ln 2^n \geq \ln(1000)$$

$$\Rightarrow n \ln 2 \geq \ln(1000)$$

$$\Rightarrow n \geq \frac{\ln(1000)}{\ln 2}$$

$$\Rightarrow n \geq 9.966$$

$$n \approx 10$$

50. In the system whose signal flow graph is shown in the figure. $U_1(s)$ and $U_2(s)$ are inputs. The transfer function $\frac{Y(s)}{U_1(s)}$ is

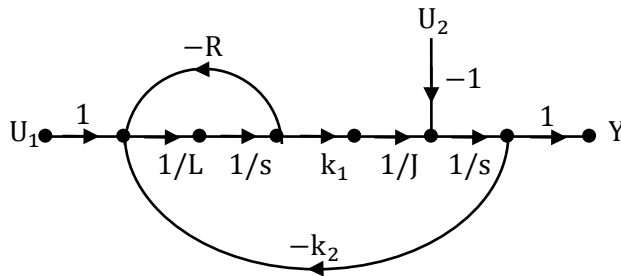

- (A) $\frac{k_1}{JLs^2 + JRS + k_1k_2}$
- (B) $\frac{k_1}{JLs^2 - JRS - k_1k_2}$
- (C) $\frac{k_1 - U_2(R + sL)}{JLs^2 + (JR - U_2L)s + k_1k_2 - U_2R}$
- (D) $\frac{k_1 - U_2(sL - R)}{JLs^2 - (JR + U_2L)s - k_1k_2 + U_2R}$

[Ans. A]

$$\frac{Y(s)}{U_1(s)} = \frac{\frac{1}{L} \cdot \frac{1}{s} \cdot K_1 \cdot \frac{1}{J} \cdot \frac{1}{s}}{1 - \left[\left(\frac{1}{L} \right) \left(\frac{1}{s} \right) (K_1) \left(\frac{1}{J} \right) \left(\frac{1}{s} \right) (-K_2) \right] - \left[\frac{-R}{LS} \right]}$$

$$= \frac{K_1}{JLs^2 + JRS + K_1K_2}$$

51. A three-phase, three winding $\Delta/\Delta/Y$ (1.1 kV/6.6 kV/400 V) transformer is energized from AC mains at the 1.1 kV side. It Supplies 900 kVA load at 0.8 power factor lag from the 6.6 kV winding and 300 kVA load at 0.6 power factor lag from the 400 V winding. The RMS line current in ampere drawn by the 1.1 kV winding from the mains is _____ .

[Ans. *] Range: 623 to 627

Given transformer is $\Delta/\Delta/Y$

Wdg(1)/Wdg(2)/Wdg(3)

$\Delta/\Delta/Y$

1.1kV/6.6kV/400V

By applying superposition theorem

(a) Load on 6.6 kV (Δ) side is 900 kVA, 0.8 Pf lag

$$\Rightarrow 900 \times 10^3 = \sqrt{3} \times 6.6 \times 10^3 \times I_L$$

$$I_L = 78.72A$$

$$I_{ph}(\text{load}) = \frac{78.72}{\sqrt{3}} = 45.46A/\text{ph}$$

$$= 45.46 \angle -36.86 A/\text{ph}$$

⇒ The current on 1.1 kV side will be

$$I_{ph}(\text{source}) = 46.46 \times \left(\frac{6.6}{1.1}\right)$$

$$= 272.76 \angle -36.86 \text{ A/ph}$$

(b) Load on 400 V (Y) is 300 kVA, 0.6 pf lag

$$\Rightarrow 300 \times 10^3 = \sqrt{3} \times 400 \times I_L$$

$$I_L = \frac{300 \times 10^3}{\sqrt{3} \times 400} = 433.01 \text{ A}$$

$$\Rightarrow I_{ph} = 433.01 \angle -53.13 \text{ A/ph}$$

∴ The current of source side (1.1 kV) will be

$$I_{ph}(\text{source}) = \frac{400/\sqrt{3}}{[1100]} \times 433.01$$

$$= 90.90 \angle -53.13 \text{ A/ph}$$

∴ Total source phase current will be

$$= 272.76 \angle -36.86 + 90.90 \angle -53.13$$

$$= 360.88 \text{ A/ph ; Pf} = 0.65 \text{ lag}$$

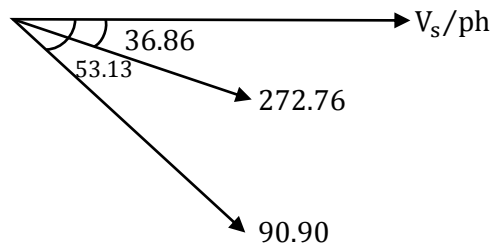

∴ The line current will be = 623 A

52. A load is supplied by a 230 V, 50 Hz source. The active power P and the reactive power Q consumed by the load are such that $1 \text{ kW} \leq P \leq 2 \text{ kW}$ and $1 \text{ kVAR} \leq Q \leq 2 \text{ kVAR}$. A capacitor connected across the load for power factor correction generates 1 kVAR reactive power. The worst case power factor after power factor correction is

- (A) 0.447 lag
(B) 0.707 lag
(C) 0.894 lag
(D) 1

[Ans. B]

Worst power factor corresponding to P_{\min} and Q_{\max}

$$P_{\min} = 1 \text{ kW}$$

$$Q_{\max} = 2 \text{ KVAR}$$

$$Q_c = 1 \text{ KVAR}$$

$$P = 1 \text{ kW}, Q = 1 \text{ KVAR}$$

$$\text{Power Factor} = \cos \left[\tan^{-1} \left(\frac{Q}{P} \right) \right] = 0.707 \text{ lag}$$

53. Let a causal LTI system be characterized by the following differential equation, with initial rest condition

$$\frac{d^2y}{dt^2} + 7 \frac{dy}{dt} + 10y(t) = 4x(t) + 5 \frac{dx(t)}{dt}$$

Where, $x(t)$ and $y(t)$ are the input and output respectively. The impulse response of the system is ($u(t)$ is the unit step function)

- (A) $2e^{-2t}u(t) - 7e^{-5t}u(t)$
- (B) $-2e^{-2t}u(t) + 7e^{-5t}u(t)$
- (C) $7e^{-2t}u(t) - 2e^{-5t}u(t)$
- (D) $-7e^{-2t}u(t) + 2e^{-5t}u(t)$

[Ans. B]

Taking the Laplace transform

$$\begin{aligned} \text{TF} &= \frac{Y(s)}{X(s)} = \frac{5s + 4}{s^2 + 7s + 10} \\ &= \frac{5s + 4}{(s + 2)(s + 5)} = -\frac{2}{s + 2} + \frac{7}{s + 5} \end{aligned}$$

$$\text{IR} = L^{-1}[\text{TF}] = -2e^{-2t}u(t) + 7e^{-5t}u(t)$$

54. The switch in the figure below was closed for a long time. It is opened at $t = 0$. The current in the inductor of 2 H for $t \geq 0$, is

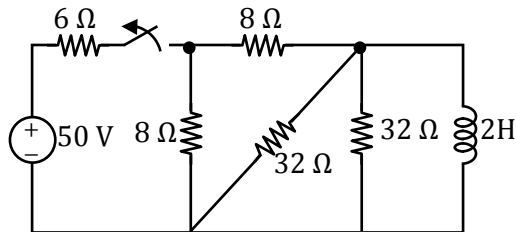

- (A) $2.5 e^{-4t}$
- (B) $5e^{-4t}$
- (C) $2.5e^{-0.25t}$
- (D) $5e^{-0.25t}$

[Ans. A]

This is source free, first order R-L circuit

$$i(t) = I_0 e^{-\frac{t}{\tau}}$$

$$I_0 \rightarrow t = 0^-$$

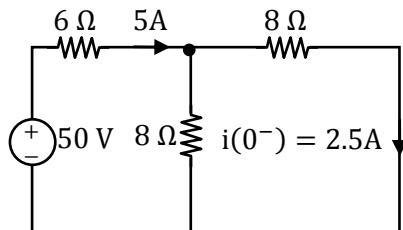

$$\tau = \frac{L}{R_{eq}}$$

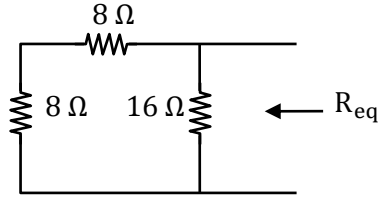

$$R_{eq} = 8\Omega \rightarrow \tau = \frac{L}{R_{equ}} = \frac{2}{8} = \frac{1}{4}$$

$$i(t) = 2.5 e^{-\frac{t}{4}}$$

$$i(t) = 2.5 e^{-4t}$$

55. The figure shows the single line diagram of a power system with a double circuit transmission line. The expression for electrical power is $1.5 \sin\delta$, where δ is the rotor angle. The system is operating at the stable equilibrium point with mechanical power equal to 1 pu. If one of the transmission line circuits is removed, the maximum value of δ , as the rotor swings is 1.221 radian. If the expression for electrical power with one transmission line circuit removed is $P_{max} \sin\delta$, the value of P_{max} , in pu is _____.

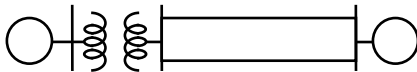

[Ans. *] Range: 1.21 to 1.23

$$\delta_2 = \delta_m = 70$$

With two lines

$$P_s = P_{e1} = P_{m1} \sin\delta_0$$

$$\delta_0 = \sin^{-1}\left(\frac{P_s}{P_{m1}}\right) = \sin^{-1}\left(\frac{1.0}{1.5}\right)$$

$$\delta_0 = 41.75^\circ = 0.728 \text{ rad}$$

$$\delta_m = 1.221 \text{ rad}$$

$$= 1.221 \times \frac{180}{3.14} = 70$$

$$A_1 + A_2 = 0$$

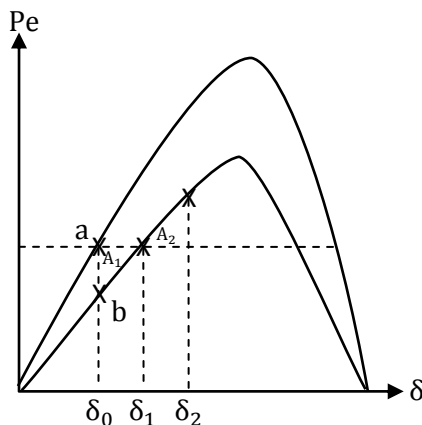

$$\int_{\delta_0}^{\delta_1} (P_s - P_{e2})d\delta + \int_{\delta_1}^{\delta_2} (P_s - P_{e2})d\delta = 0$$

$$\begin{aligned} [P_s \delta + P_{m_2} \cos \delta]_{\delta_0}^{\delta_1} + [P_s \delta + P_{m_2} \cos \delta]_{\delta_1}^{\delta_2} &= 0 \\ P_s \delta_1 - P_s \delta_0 + P_{m_2} \cos \delta_1 - P_{m_2} \cos \delta_0 + P_s \delta_2 - P_s \delta_1 + P_{m_2} \cos \delta_2 - P_{m_2} \cos \delta_1 &= 0 \\ P_s (\delta_2 - \delta_0) + P_{m_2} (\cos \delta_2 - \cos \delta_0) &= 0 \\ 1.0 (1.221 - 0.728) + P_{m_2} (\cos 70 - \cos 41.75) &= 0 \\ 0.493 + P_{m_2} (0.342 - 0.746) &= 0 \\ P_{m_2} = \frac{0.493}{0.404} &= 1.22 \\ P_{m_2} &= 1.22 \end{aligned}$$